

**ISOTOP® Boost chopper
NPT IGBT**

**$V_{CES} = 600V$
 $I_C = 100A @ T_c = 80^\circ C$**

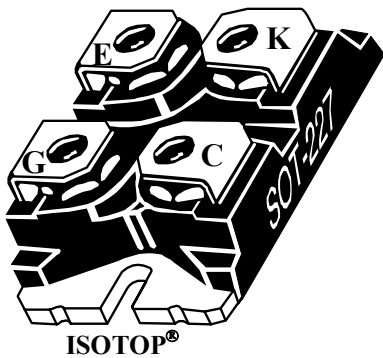
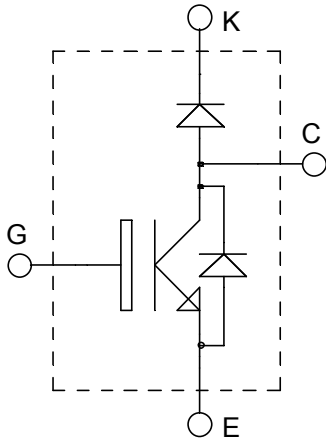

Application

- AC and DC motor control
- Switched Mode Power Supplies
- Power Factor Correction
- Brake switch

Features

- Non Punch Through (NPT) THUNDERBOLT IGBT®
 - Low voltage drop
 - Low tail current
 - Switching frequency up to 100 kHz
 - Soft recovery parallel diodes
 - Low diode VF
 - Low leakage current
 - Avalanche energy rated
 - RBSOA and SCSOA rated
- ISOTOP® Package (SOT-227)
- Very low stray inductance
- High level of integration

Benefits

- Outstanding performance at high frequency operation
- Stable temperature behavior
- Very rugged
- Direct mounting to heatsink (isolated package)
- Low junction to case thermal resistance
- Easy paralleling due to positive TC of VCEsat

Absolute maximum ratings

Symbol	Parameter	Max ratings	Unit
V_{CES}	Collector - Emitter Breakdown Voltage	600	V
I_{C1}	Continuous Collector Current	$T_C = 25^\circ C$	120
I_{C2}		$T_C = 80^\circ C$	100
I_{CM}	Pulsed Collector Current	$T_C = 25^\circ C$	320
V_{GE}	Gate - Emitter Voltage	± 20	V
P_D	Maximum Power Dissipation	$T_C = 25^\circ C$	416
$I_{F_{AV}}$	Maximum Average Forward Current	Duty cycle=0.5	$T_C = 80^\circ C$
$I_{F_{RMS}}$	RMS Forward Current (Square wave, 50% duty)		39

CAUTION: These Devices are sensitive to Electrostatic Discharge. Proper Handling Procedures Should Be Followed.

All ratings @ $T_j = 25^\circ\text{C}$ unless otherwise specified

Electrical Characteristics

Symbol	Characteristic	Test Conditions	Min	Typ	Max	Unit
BV_{CES}	Collector - Emitter Breakdown Voltage	$V_{GE} = 0V, I_C = 100\mu A$	600			V
I_{CES}	Zero Gate Voltage Collector Current	$V_{GE} = 0V$ $V_{CE} = 600V$			100	μA
					1000	
$V_{CE(on)}$	Collector Emitter on Voltage	$V_{GE} = 15V$ $I_C = 100A$		2.0	2.5	V
				2.2		
$V_{GE(th)}$	Gate Threshold Voltage	$V_{GE} = V_{CE}, I_C = 1mA$	3		5	V
I_{GES}	Gate - Emitter Leakage Current	$V_{GE} = \pm 20V, V_{CE} = 0V$			± 150	nA

Dynamic Characteristics

Symbol	Characteristic	Test Conditions	Min	Typ	Max	Unit
C_{ies}	Input Capacitance	$V_{GE} = 0V$		4300		pF
C_{oes}	Output Capacitance	$V_{CE} = 25V$		470		
C_{res}	Reverse Transfer Capacitance	$f = 1MHz$		400		
Q_g	Total gate Charge	$V_{GS} = 15V$		330		nC
Q_{ge}	Gate - Emitter Charge	$V_{Bus} = 300V$		290		
Q_{gc}	Gate - Collector Charge	$I_C = 100A$		200		
$T_{d(on)}$	Turn-on Delay Time	Resistive Switching (25°C)		26		ns
T_r	Rise Time	$V_{GE} = 15V$		25		
$T_{d(off)}$	Turn-off Delay Time	$V_{Bus} = 400V$		150		
T_f	Fall Time	$I_C = 100A$		30		
E_{on}	Turn-on Switching Energy	$R_G = 5\Omega$		3.35		
E_{off}	Turn off Switching Energy			2.85		mJ
$T_{d(on)}$	Turn-on Delay Time	Inductive Switching (125°C)		26		ns
T_r	Rise Time	$V_{GE} = 15V$		25		
$T_{d(off)}$	Turn-off Delay Time	$V_{Bus} = 400V$		170		
T_f	Fall Time	$I_C = 100A$		40		
E_{on}	Turn-on Switching Energy	$R_G = 5\Omega$		4.3		
E_{off}	Turn-off Switching Energy			3.5		mJ

Diode ratings and characteristics

<i>Symbol</i>	<i>Characteristic</i>	<i>Test Conditions</i>		<i>Min</i>	<i>Typ</i>	<i>Max</i>	<i>Unit</i>
V _F	Diode Forward Voltage	I _F = 30A			1.6	1.8	V
		I _F = 60A			1.9		
		I _F = 30A	T _j = 125°C		1.4		
I _{RM}	Maximum Reverse Leakage Current	V _R = 600V	T _j = 25°C			250	μA
		V _R = 600V	T _j = 125°C			500	
C _T	Junction Capacitance	V _R = 200V			44		pF
t _{rr}	Reverse Recovery Time	I _F = 1A, V _R = 30V	T _j = 25°C		23		ns
	Reverse Recovery Time	di/dt = 100A/μs	T _j = 25°C		85		
			T _j = 125°C		160		
I _{RRM}	Maximum Reverse Recovery Current	I _F = 30A V _R = 400V di/dt = 200A/μs	T _j = 25°C		4		A
			T _j = 125°C		8		
Q _{rr}	Reverse Recovery Charge		T _j = 25°C		130		nC
			T _j = 125°C		700		
t _{rr}	Reverse Recovery Time	I _F = 30A	T _j = 125°C		70		ns
Q _{rr}	Reverse Recovery Charge	V _R = 400V			1300		nC
I _{RRM}	Maximum Reverse Recovery Current	di/dt = 1000A/μs			30		A

Thermal and package characteristics

<i>Symbol</i>	<i>Characteristic</i>		<i>Min</i>	<i>Typ</i>	<i>Max</i>	<i>Unit</i>
R _{thJC}	Junction to Case	IGBT			0.3	°C/W
		Diode			1.21	
R _{thJA}	Junction to Ambient (IGBT & Diode)				20	
V _{ISOL}	RMS Isolation Voltage, any terminal to case t = 1 min, I _{isol} < 1mA, 50/60Hz		2500			V
T _J , T _{STG}	Storage Temperature Range		-55		150	°C
T _L	Max Lead Temp for Soldering: 0.063" from case for 10 sec				300	
Torque	Mounting torque (Mounting = 8-32 or 4mm Machine and terminals = 4mm Machine)				1.5	N.m
Wt	Package Weight			29.2		g

Typical IGBT Performance Curve

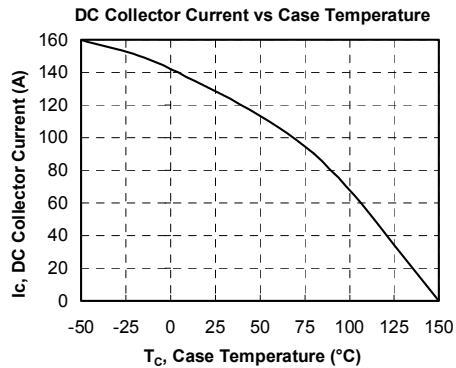
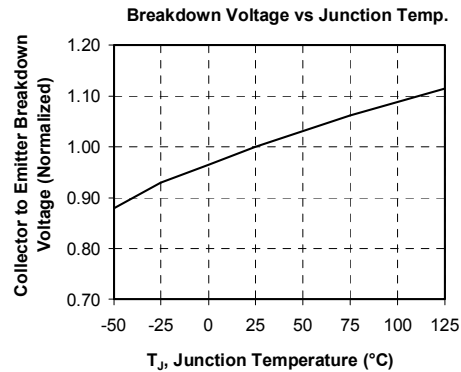
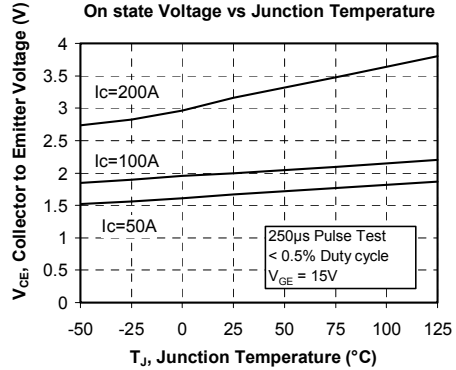
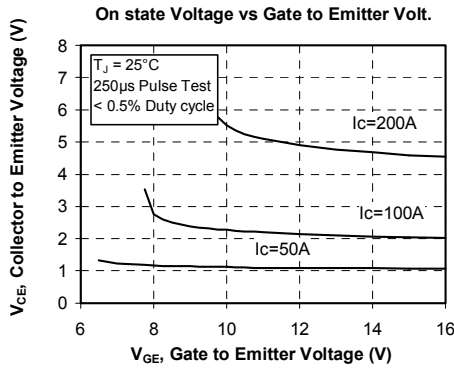
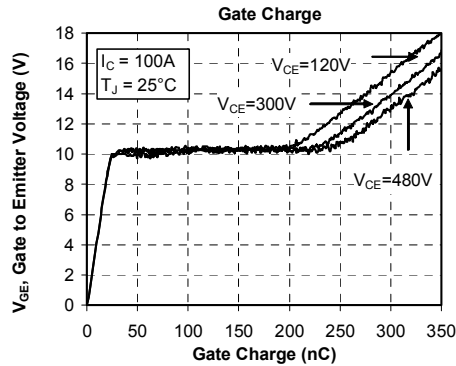
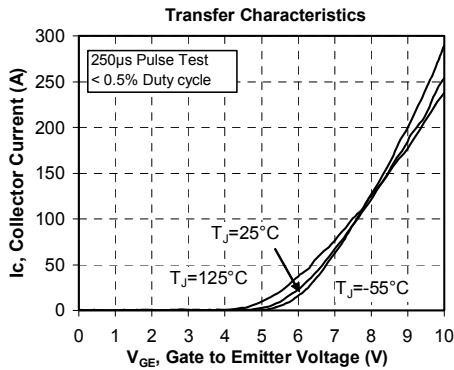
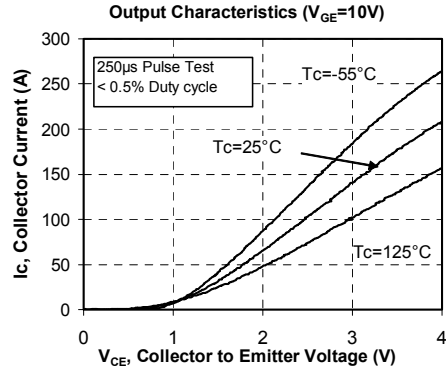
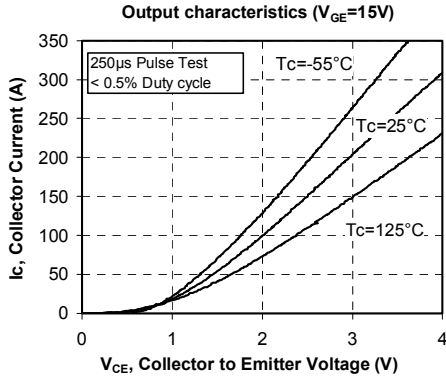

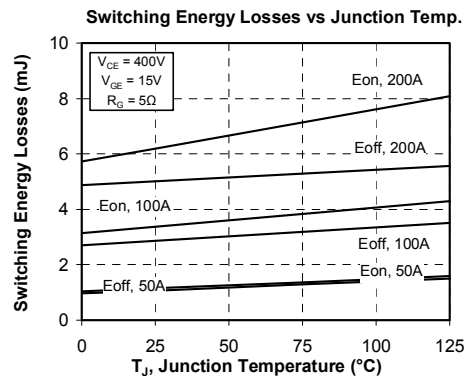
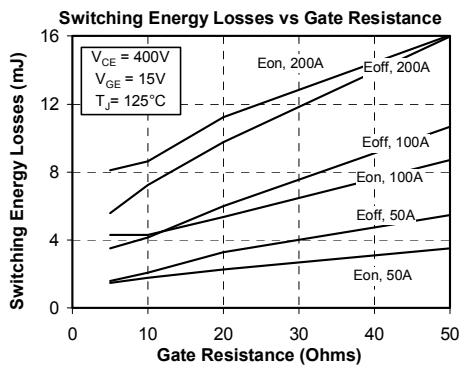
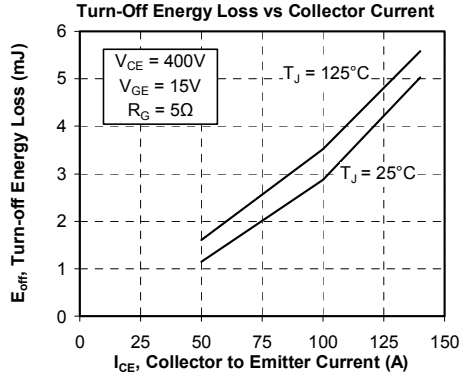
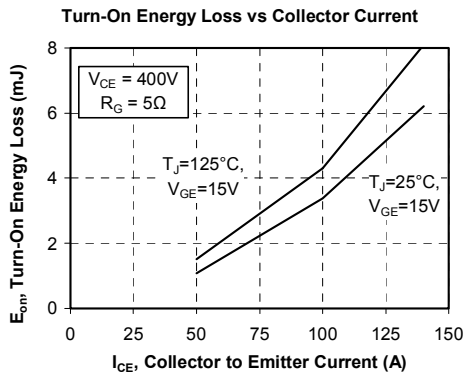
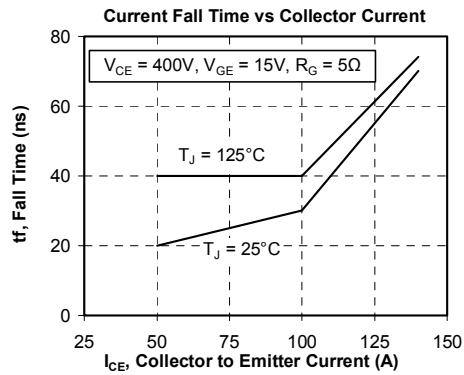
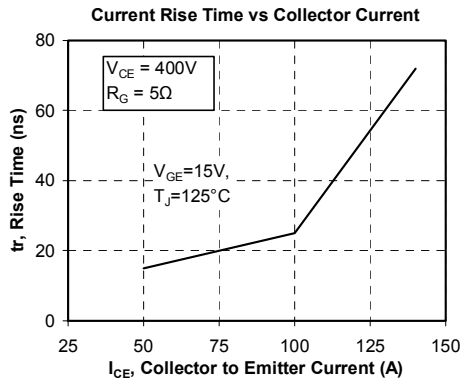
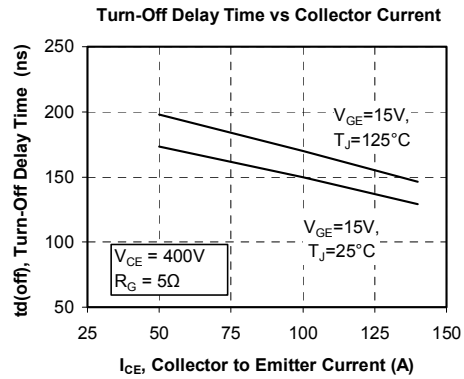
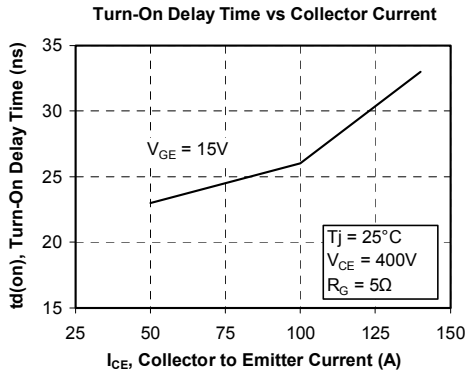

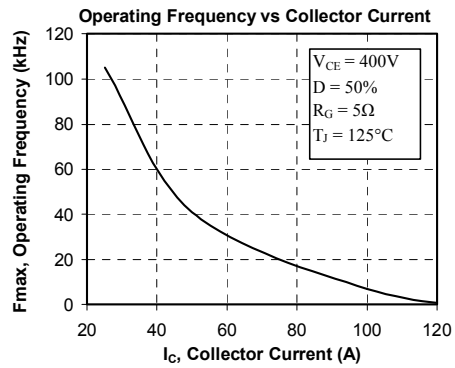
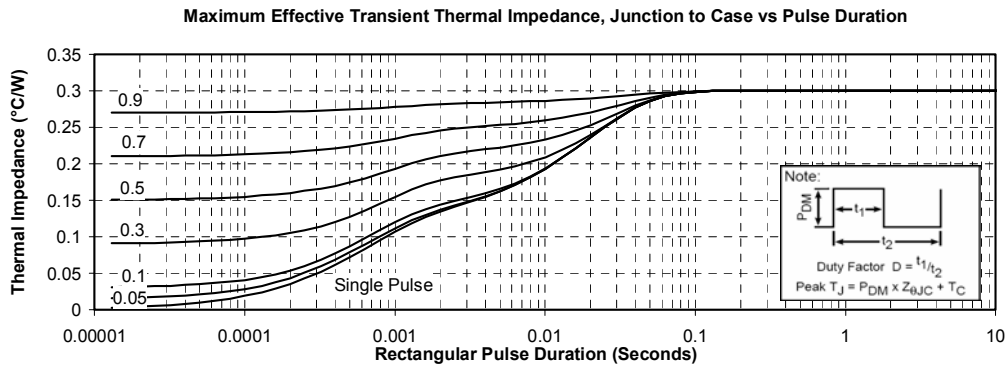
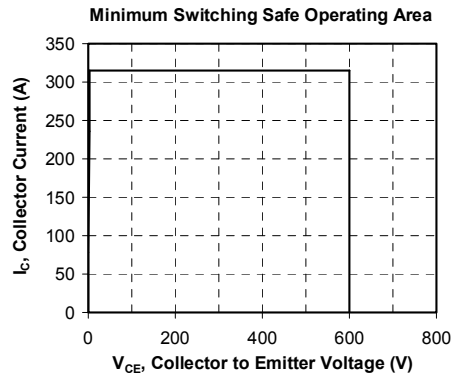
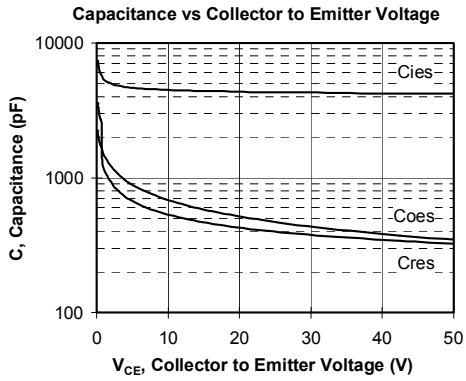

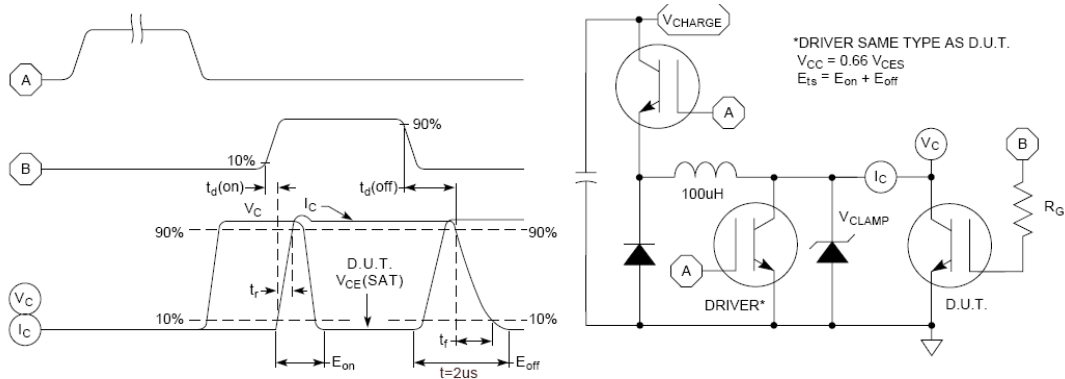

Figure 15, Switching Loss Test Circuit and Waveforms

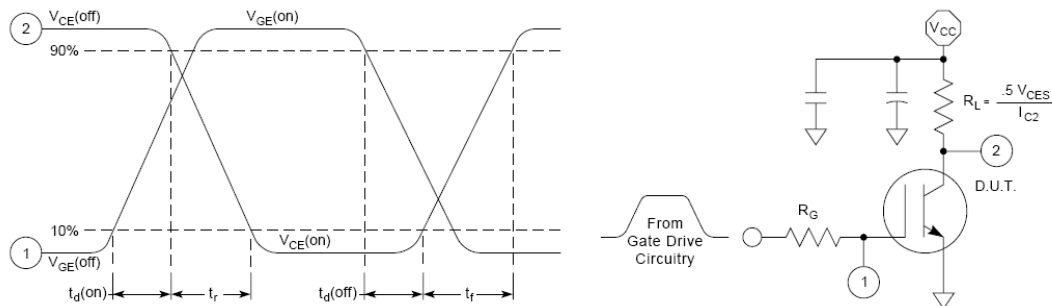

Figure 16, Resistive Switching Time Test Circuit and Waveforms

Typical Diode Performance Curve

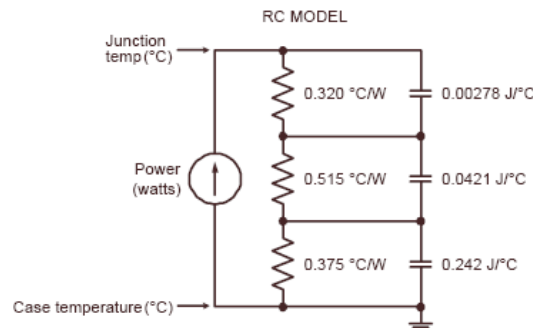
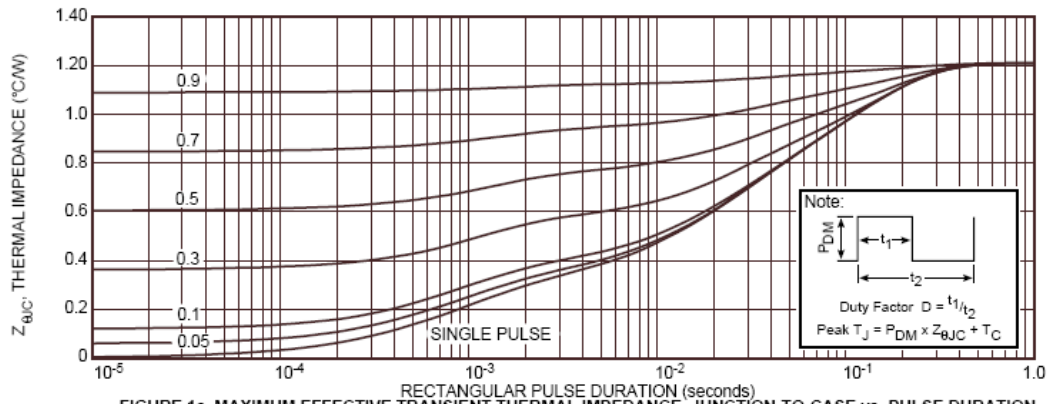

FIGURE 1b, TRANSIENT THERMAL IMPEDANCE MODEL

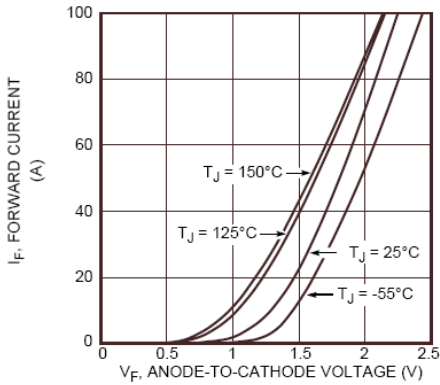

Figure 2. Forward Current vs. Forward Voltage

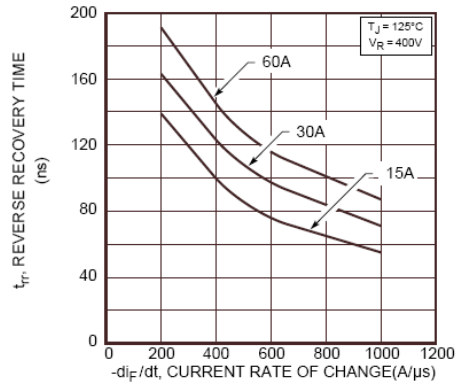

Figure 3. Reverse Recovery Time vs. Current Rate of Change

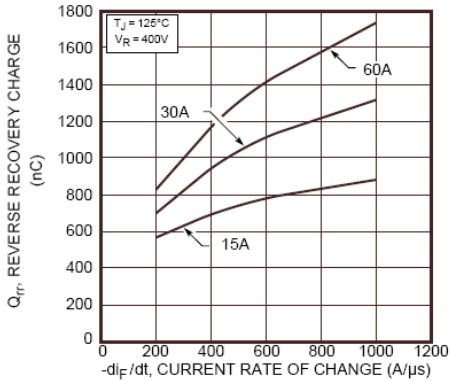

Figure 4. Reverse Recovery Charge vs. Current Rate of Change

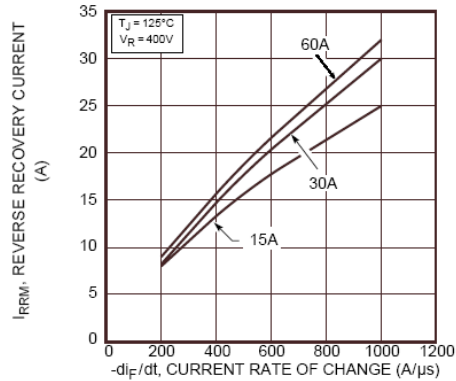

Figure 5. Reverse Recovery Current vs. Current Rate of Change

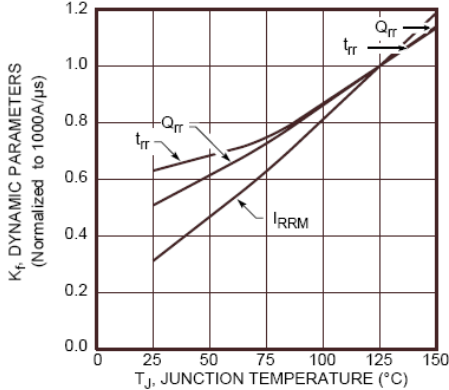

Figure 6. Dynamic Parameters vs. Junction Temperature

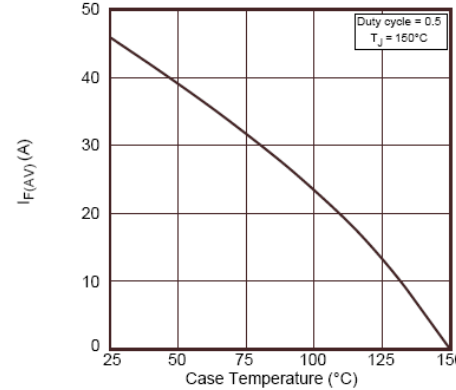

Figure 7. Maximum Average Forward Current vs. Case Temperature

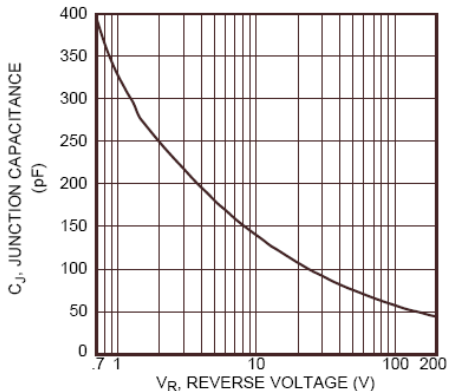

Figure 8. Junction Capacitance vs. Reverse Voltage

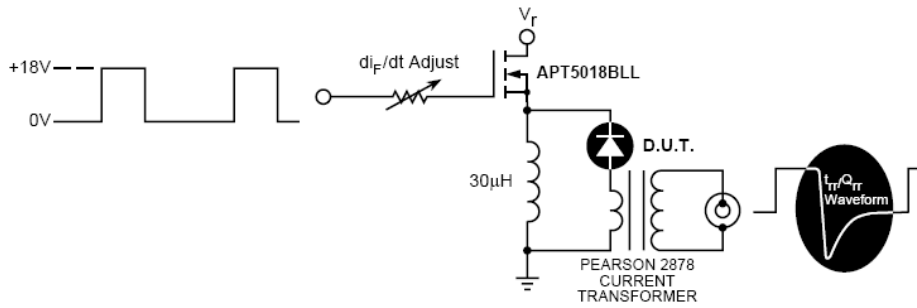

Figure 9. Diode Test Circuit

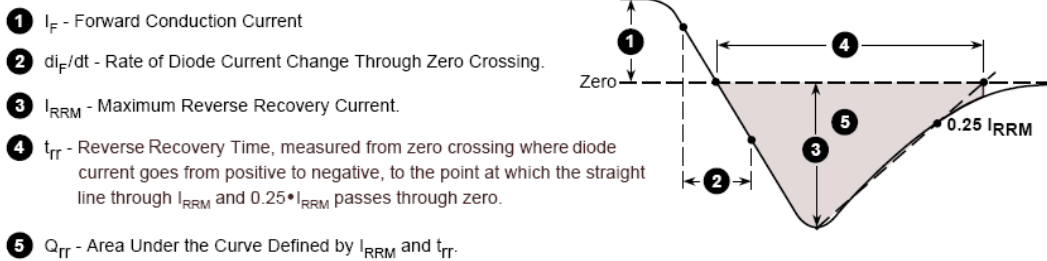
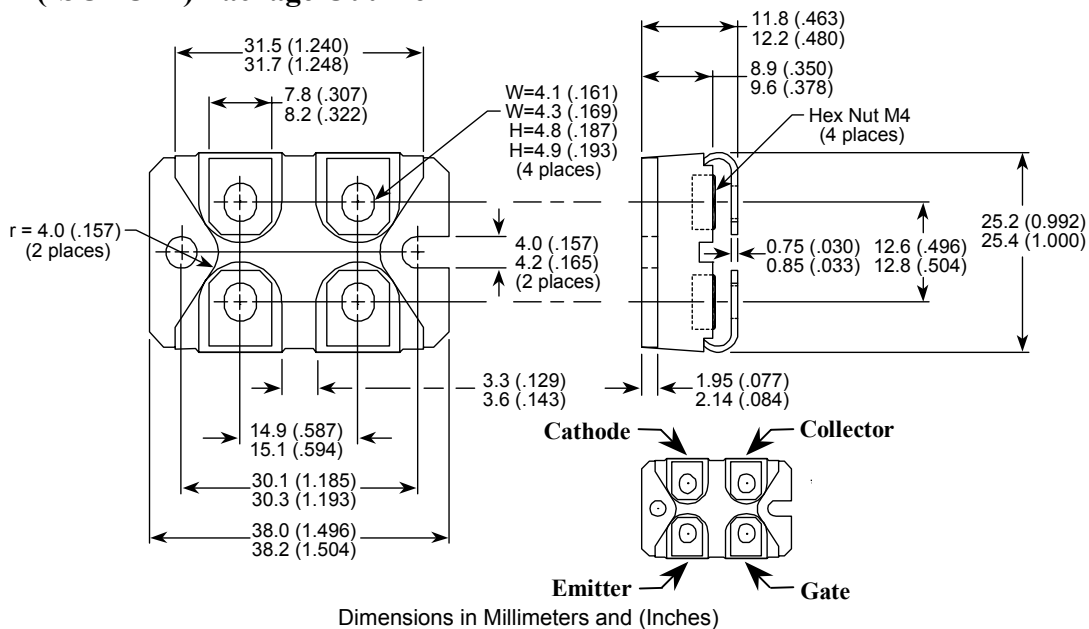

Figure 10. Diode Reverse Recovery Waveform and Definitions

SOT-227 (ISOTOP®) Package Outline



ISOTOP® is a Registered Trademark of SGS Thomson

APT reserves the right to change, without notice, the specifications and information contained herein

APT's products are covered by one or more of U.S. patents 4,895,810 5,045,903 5,089,434 5,182,234 5,019,522 5,262,336 6,503,786 5,256,583 4,748,103 5,283,202 5,231,474 5,434,095 5,528,058 and foreign patents. U.S. and Foreign patents pending. All Rights Reserved.